

 **KUNG LONG BATTERIES INDUSTRIAL CO., LTD.**

www.klb.com.tw

Taiwan
 No.6, Tzu-Li 3 Rd. Nantou City 540029, Taiwan
 TEL: +886-49-2254-777
 FAX: +886-49-2255-139
 http: //www.klb.com.tw
 E-mail: sales@mail.klb.com.tw

Vietnam
 LE LONG VIETNAM CO., LTD.
 Cụm Công Nghiệp Đức Mỹ,xã Đức Hòa Đông,
 Huyện Đức Hòa, Tỉnh Long An, 850000 Việt Nam
 TEL: +84-272-3779666
 http: //www.lelong.com.vn

USA
 1 Cape Danbury, Newport Beach, CA 92660
 TEL: +1 949-307-8720 / +1 949-328-7936
 FAX: +1 949-266-9917
 http: //www.kunglong.com
 E-mail: sales@kunglong.com



@Copyright 2024.01
 All rights of the manufacturer and of the owner of recorded work reserved. Unauthorized duplication is violation of applicable laws.
 Contents in this catalog are subject to change for improvement without prior notice to users. For clarifications and updated information, please contact us.

AC Design 04-27071159



LONG[®] BATTERY

Product Catalog

COMPANY INTRODUCTION

ABOUT KUNG LONG

Leading Through Excellence Since 1990

Since its founding in 1990, Kung Long Batteries has emerged as Taiwan's premier listed specialist lead-acid battery manufacturer. With a steadfast dedication to excellence, our journey has been marked by innovation, growth, and unwavering commitment.

Since
1990

Our Operations and Achievements

Operating from advanced facilities across Taiwan and Vietnam, we combine cutting-edge technology with a legacy of manufacturing expertise. Our commitment to quality is underscored by our ISO 9001, ISO 45001, ISO 17025, and IATF16949 certifications, affirming our adherence to the highest standards.

Innovative Partnerships and Breakthroughs

Since 1993, we have collaborated with the Industrial Technology Research Institute's Material and Chemical Research Laboratories. This partnership has yielded transformative battery solutions, including deep-cycle sealed batteries, electric scooter batteries, and high-power surface modified batteries.

Global Recognition and Customer-Centric Approach

Our products have garnered support and praise from esteemed international corporations, a testament to our unwavering commitment to quality. We firmly believe that customer satisfaction goes beyond the product itself; it encompasses attentive service and strong client relationships that add value and enhance experiences.

Awards and Distinctions

We proudly hold the Gold Award for Customer Satisfaction, a testament to our dedication to exceeding customer expectations. The Taiwan Excellence Award from the Ministry of Economic Affairs further highlights our belief in innovation as a means to provide solutions that address customer needs.

Continuing the Journey

From our humble beginnings in 1990 to our position as an industry leader, Kung Long Batteries remains committed to innovation, quality, and customer satisfaction. Our unwavering resolve propels us forward, as we continue to pioneer battery solutions that shape industries and empower the future.

1990
was Founded

IPO
TWSE 1537

IATF
16949
Certified

3800+
Employees

1996
Vietnam
cultivation
began



HISTORY

Our expertise comes from our ample experiences

- 2023** Obtained IATF 16949 Automotive Quality Management System
- 2022** Awarded Kaizen Champion by Schneider Electric (SE)
- 2020** HTP12100A Awarded "TAIWAN EXCELLENCE" by Ministry of Economic Affairs
- 2019** Obtained ISO 45001 Occupational Health and Safety Management Systems
- 2019** Awarded Excellent Supplier by Honda Vietnam
- 2018** Qualified Supplier by TOP 3 Telecom Companies in Taiwan- Chunghwa Telecom (CHT), Taiwan Mobile, and Far EasTone Telecom
- 2018** Qualified Supplier by GDS Data Center in Vietnam
- 2017** Obtained ISO 17025 Certificate of Accreditation
- 2017** Awarded CHAMPION of Excellent Supplier By Schneider Electric (SE)
- 2017** Qualified Supplier by TOP 3 Telecom Companies in Vietnam-Viettel, VNPT, and Mobifone
- 2016** Developed and Accomplished High Temperature Batteries, HTP Series
- 2015** Qualified by HONDA for ISS Motorcycle Battery
- 2015** Qualified as Green Supplier by Schneider Electric (SE)
- 2012** Developed and Accomplished Long Life Batteries, WPL Series
- 2012** Qualified Supplier from Various Public Transportation System Continuously in Taiwan, Including Taipei, Taoyuan, Hsinchu, Taichung, Tainan, and Kaohsiung
- 2010** Introduce New CI (Corporate Identity)
- 2010** Developed and Accomplished Stationary Batteries, MSK & TPK Series
- 2007** Established the 2nd Plant (Duc Hoa) in Vietnam Where Occupies 350,000 Square Meters
- 2002** Obtained OHSAS 18001 International Safety Management System Certificate
- 2002** Qualified by APC by Schneider Electric (SE)
- 2001** Approved for a Listed Company in Taiwan Stock Exchange Market. (TWSE:1537)
- 2000** Obtained ISO 9001 International Quality Management System Certificate
- 1999** Obtained ISO 14001 International Environmental Certificate
- 1998** Awarded with the " Excellence of Taiwan Award" by the Ministry of Economic Affairs
- 1996** Obtained VdS German Product Safety Approval
- 1996** Established LE LONG VIET NAM CO., LTD.
- 1993** Developed Deep-Cycle SLA Batteries with Industrial Technology Research Institute's Material and Chemical Research Laboratories
- 1991** Obtained UL mark for US Product Safety Standards
- 1990** Kung Long was Approved to Establish in Nan Kang Industrial Park

Power your life LONG[®] BATTERY

RENEWABLE ENERGY

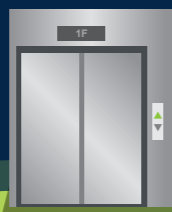

GENERAL PURPOSE



MARINE/ RV.
AGM DUAL PURPOSE



HIGH TEMP.
SERIES



DEEP CYCLE HME MOBILITY



UPS/ HIGH RATE
LONG LIFE

TELECOM



INDEX

- 05 PRODUCT OVERVIEW
- 07 SPECIFICATION
- 11 TECHNOLOGY
- 13 WXL SERIES
- 17 TPK & MSK & HTP SERIES
- 19 WPG & CWP SERIES
- 21 PLG (FULL GEL) SERIES

PRODUCT OVERVIEW

CONSTRUCTION

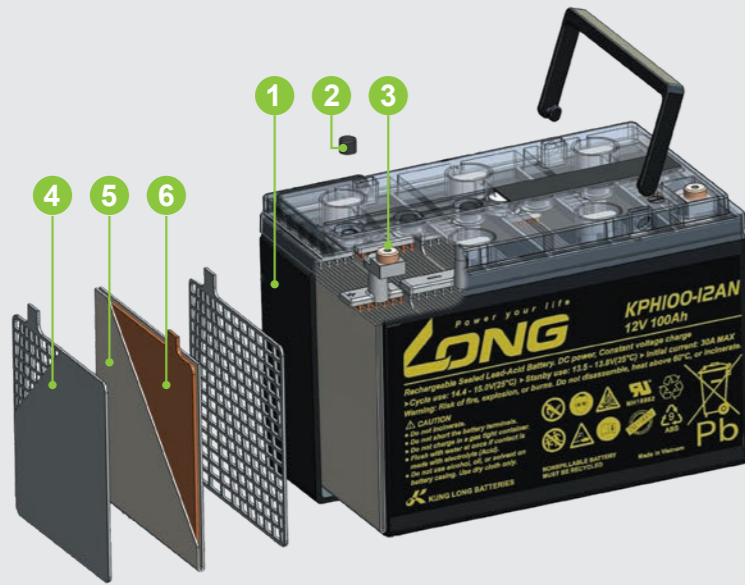

- 1 Top Lid/ Middle Cover/ Container**
Select mechanically strong ABS material
- 2 Safety Valve**
A one-way valve made of chloroprene rubber
- 3 Terminal**
Cooper plated
- 4 Negative Plate**
99.99% pure lead with an exclusive paste for dependability and reliability
- 5 Separator**
Absorbed glass mat separators to absorb the electrolyte and make the battery spill-proof
- 6 Positive Plate**
Strong grid design to withstand corrosion

BATTERY NUMBERING SYSTEM

WP2.9-12TR

Battery Type

- WP General Purpose
- WPS UPS Back Up Series
- WPL Long Life Series
- U1 Sealed Battery with Conventional Dimension
- KPH High Power Type
- 22NF BCI Group for Light Truck
- MSK 2V Stationary Series
- TPK 12V Front Terminal Series
- LG Gel Batteries Series
- HTP High Temperature Series
- WPG Green Power Series
- PLG Pure Gel Series
- WXL Extreme High Rate

Battery Capacity At 20/ 10 Hr Rate

Battery Voltage

Battery Features

- R : Negative Terminal Position
- N : Type of Terminal, N : Nut
- E : Electric Vehicle Power
- W : Battery Capacity ST W/ cell at 15 Min. Rate
- A, S, T : Same Capacity with Different Dimensions or Purpose
- I : Inner Terminal Position
- H : Handle Type

WP 12 36W

Battery Voltage

Battery Capacity ST W/ cell at 15 Min. Rate

TERMINAL TYPE

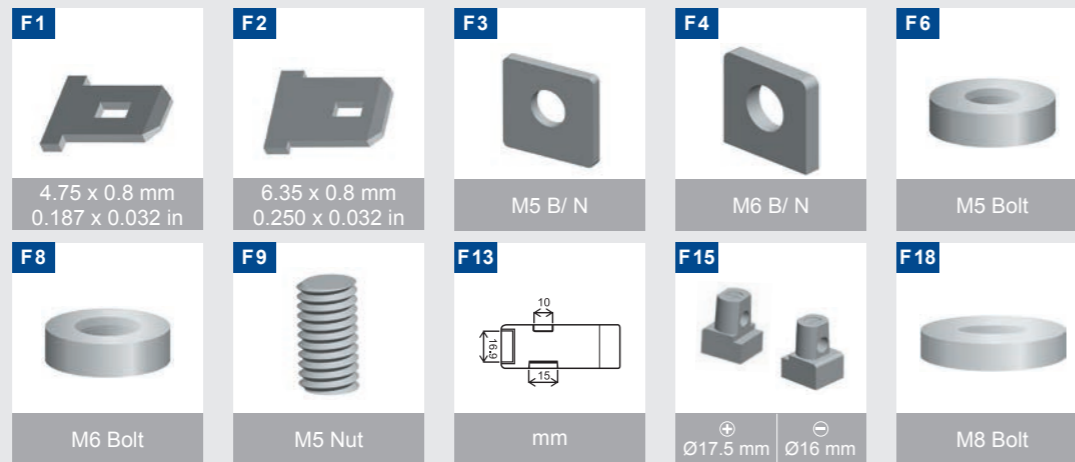

TERMINAL POSITION

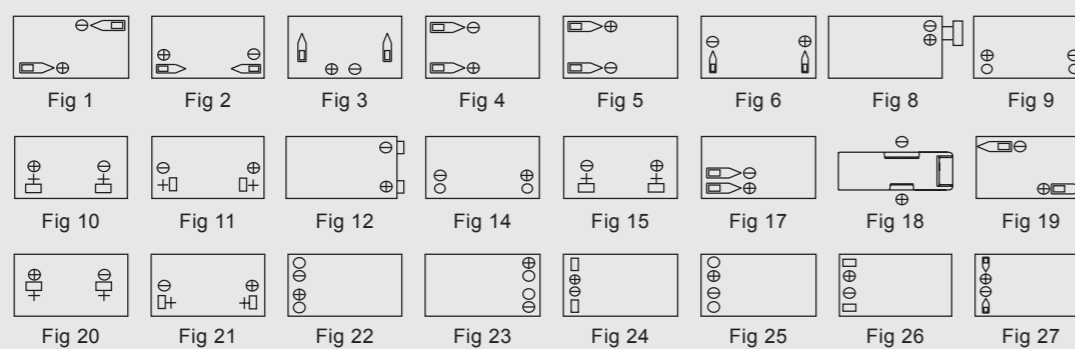

VRLA BATTERIES



1000Ah ↑
0.7Ah ↓

Full capacity from 0.7Ah to 1000Ah

Pb 99%
high purity

Constructed with high purity lead 99.990wt% above

Non-Spillable

Maintenance Free & Non-Spillable

99%

The gas recombination efficiency is up to 99%

LONG
Life

Built to last

ABS

Rugged impact resistance
ABS CASE; FR version
(UL94-V0) in option

SPECIFICATION

BATTERY TYPE	NOMINAL VOLTAGE (V)	NOMINAL CAPACITY (Ah)		DIMENSION								WEIGHT (APPROX.)		ASSEMBLY FIGURE	
		5HR	20HR	L	W	H	HT	L	W	H	HT	kg	lbs	TERMINAL POSITION	TERMINAL TYPE
				mm	mm	mm	mm	in	in	in	in				

GENERAL PURPOSE

WP4.5-4	4	3.825	4.5	48.5	52.5	94	100	1.91	2.07	3.70	3.94	0.63	1.39	3	F2
WP9-4	4	7.65	9	101	44	95	102	3.98	1.73	3.74	4.02	1.18	2.60	3	F2
WP1.2-6	6	1.02	1.2	97	25	52	57	3.82	0.98	2.05	2.24	0.289	0.64	2	F1
WP7-6	6	5.95	7	151	34	94	100	5.94	1.34	3.70	3.94	1.23	2.71	2	F1
WP7-6S	6	5.95	7	116	50	92	99	4.57	1.97	3.62	3.90	1.45	3.19	1	F1
WP9-6A	6	7.65	9	98.5	56	118	118	3.88	2.20	4.65	4.65	1.70	3.74	19	F1
WP10-6	6	8.5	10	151	50	94	100	5.94	1.97	3.7	3.94	1.70	3.74	2	F1
WP12-6S	6	10.2	12	151	50	94	99	5.94	1.97	3.7	3.90	1.84	4.05	2	F1
WP13-6	6	11.05	13	108	70	140	140	4.25	2.76	5.51	5.51	2.24	4.93	17	F1-,F2+
WP20-6	6	17	20	157	83	125	125	6.18	3.27	4.92	4.92	3.89	8.56	20	F3
WP0.7-12	12	0.595	0.7	96	25	62	62	3.78	0.98	2.44	2.44	0.36	0.80	8	Wire/A
WP0.7-12S	12	0.595	0.7	96	25	62	62	3.78	0.98	2.44	2.44	0.36	0.80	8	Wire/J
WP1.2-12★	12	1.02	1.2	97	43	53	59	3.82	1.69	2.09	2.32	0.55	1.21	4	F1
WP1.2-12T	12	1.02	1.2	97	48	50	56	3.82	1.89	1.97	2.20	0.58	1.28	4	F1
WP2.2-12★	12	1.87	2.2	178	34	60	66	7.01	1.34	2.36	2.60	0.985	2.17	2	F1
WP2.3-12	12	1.955	2.3	178	34.5	60	66	7.01	1.36	2.36	2.60	0.965	2.12	2	F1
WP2.6-12	12	2.21	2.6	178	34.5	60	66	7.01	1.36	2.36	2.60	0.965	2.12	2	F1
WP2.9-12T	12	2.465	2.9	79	56	99	107	3.11	2.20	3.90	4.21	1.19	2.62	6	F1
WP2.9-12TR	12	2.465	2.9	79	56	99	107	3.11	2.20	3.90	4.21	1.19	2.62	3	F1
WP3-12	12	2.55	3	134	67	59.5	65.5	5.28	2.64	2.34	2.58	1.30	2.86	4	F1
WP4.5-12	12	3.825	4.5	90	70	101.5	107	3.54	2.76	4.00	4.21	1.62	3.56	3	F1
WP5-12	12	4.25	5	90	70	101.5	107	3.54	2.76	4.00	4.21	1.90	4.18	3	F1
WP7.2-12★	12	6.12	7.2	151	65	94	102	5.94	2.56	3.70	4.02	2.40	5.28	5	F1
WP12-12A★	12	10.2	12	151	98	93	98	5.94	3.86	3.66	3.86	3.75	8.25	5	F1
WP18-12I★	12	15.3	18	181	76	167	167	7.13	2.99	6.57	6.57	6.30	13.86	11	F3
WP18-12N★	12	15.3	18	181	76	167	167	7.13	2.99	6.57	6.57	6.30	13.86	14	F6
WP20-12I	12	17	20	181	76	167	167	7.13	2.99	6.57	6.57	5.95	13.09	11	F3
WP20-12N	12	17	20	181	76	167	167	7.13	2.99	6.57	6.57	5.95	13.09	14	F6
WP22-12N	12	18.7	22	181	76	167	167	7.13	2.99	6.57	6.57	6.90	15.18	14	F8
WP22-12NSHR	12	18.7	22	181	77	170	170	7.13	3.03	6.69	6.69	7.00	15.40	14	F6
WP24-12(N)★	12	20.4	24	166	175	125	125	6.54	6.89	4.92	4.92	8.00	17.60	21(14)	F3(F6)
WP26-12(N)★	12	22.1	26	166	175	125	125	6.54	6.89	4.92	4.92	9.30	20.46	21(14)	F3(F6)
WP26-12TN	12	22.1	26	166	125.5	176	176	6.54	4.94	6.93	6.93	8.80	19.36	14	F6
WP30-12TN	12	25.5	30	166	125.5	176	176	6.54	4.94	6.93	6.93	9.30	20.50	14	F6
WP40-12(N)	12	34	40	197.7	166	171	171	7.78	6.54	6.73	6.73	13.50 (13.40)	29.70 (29.50)	11(14)	F4(F8)
WP45-12(N)★	12	38.25	45	197.7	166	171	171	7.78	6.54	6.73	6.73	14.50	31.90	11(14)	F4(F8)
WP50-12(N)	12	42.5	50	199	166	171	171	7.83	6.54	6.73	6.73	15.10	33.22	11(14)	F4(F8)
WP55-12(N)	12	46.75	55	226	135	207	229 (214)	8.90	5.31	8.15	9.02 (8.43)	17.10	37.62	10(9)	F15(F8)
WP65-12(N)★	12	55.25	65	350	166	174	174	13.78	6.54	6.85	6.85	23.30	51.26	15(14)	F4(F8)
KPH65-12N	12	55.25	65	260	170	202	207	10.24	6.69	7.95	8.15	21.50	47.30	9	F8
KPH75-12N	12	63.75	75	260	170	202	207	10.24	6.69	7.95	8.15	24.20	53.24	9	F8
KPH80-12N	12	68	80	260	170	202	207	10.24	6.69	7.95	8.15	24.20	53.24	9	F8
KPH100-12AN(AU)	12	85	100	307	168	208	213 (230)	12.09	6.61	8.19	8.39 (9.06)	30.00	66.00	9(10)	F8(F15)
KPH110-12N	12	93.5	110	338	170	212	217	13.31	6.69	8.35	8.54	31.20	68.60	9	F8
KPH150-12N	12	127.5	150	352	170	273	278	13.86	6.69	10.75	10.95	46.00	101.20	9	F8

- VdS Approved Model ★
- For batteries' capacity below 18Ah, all dimensions given are +/-1mm (0.04 inches)

BATTERY TYPE	NOMINAL VOLTAGE (V)	NOMINAL CAPACITY (Ah)		DIMENSION								WEIGHT (APPROX.)		ASSEMBLY FIGURE	
		5HR	20HR	L	W	H	HT	L	W	H	HT	kg	lbs	TERMINAL POSITION	TERMINAL TYPE
				mm	mm	mm	mm	in	in	in	in				

UPS / HIGH RATE

WP634W	6	34W	8.5	151	34	94	100	5.94	1.34	3.70	3.94	1.30	2.86	2	F2
WP1213W	12	13W	3.3	134	67	59.5	65.5	5.28	2.64	2.34	2.58	1.30	2.86	4	F2
WP5-12	12	4.25	5	90	70	101.5	107	3.54	2.76	4.00	4.21	1.90	4.18	3	F2
WP5-12SHR	12	4.25	5	90	70	101.5	107	3.54	2.76	4.00	4.21	1.93	4.25	3	F2
WP1224W	12	24W	6	151	51	94	101	5.94	2.01	3.70	3.98	1.95	4.29	5	F2
WP7-12(28W)(T)★	12	28W	7	151	65	94	102 (106)	5.94	2.56	3.70	4.02 (4.17)	2.18 (2.19)	4.80 (4.82)	5	F2(F3)
WP1234W	12	34W	8.5	151	65	94	102	5.94	2.56	3.70	4.02	2.50	5.50	5	F2
WP1236W(T)	12	36W	9	151	65	94	102 (106)	5.94	2.56	3.70	4.02 (4.17)	2.70	5.94	5	F2(F3)
WPS580	12	580W	9	151	65	94	102	5.94	2.56	3.70	4.02	2.85	6.27	5	F2
WP1251W★	12	51W	12	151	98	93	98	5.94	3.86	3.66	3.86	3.65	8.03	5	F2
WP12-12A★	12	10.2	12	151	98	93	98	5.94	3.86	3.66	3.86	3.75	8.25	5	F2
WP18-12(N)SHR★	12	15.3	18	181	76	167	167	7.13	2.99	6.57	6.57	5.60	12.32	11(14)	F3(F6)
WP20-12I	12	17	20	181	76	167	167	7.13	2.99	6.57	6.57	5.95	13.09	11	F3
WP20-12N	12	17	20	181	76	167	167	7.13	2.99	6.57	6.57	5.95	13.09	14	F6
WP22-12N	12	18.7	22	181	76	167	167	7.13	2.99	6.57	6.57	6.90	15.18	14	F8
WP22-12NSHR	12	18.7	22	181	77	170	170	7.13	3.03	6.69	6.69	7.00	15.40	14	F6
WP26-12(N)★	12	22.1	26	166	175	125	125	6.54	6.89	4.92	4.92	9.30	20.46	21(14)	F3(F6)
WP30-12TN	12	25.5	30	166	125.5	176	176	6.54	4.94	6.93	6.93	9.30	20.50	14	F6
WP40-12(N)	12	34	40	197.7	166	171	171	7.78	6.54	6.73	6.73	13.50 (13.40)	29.70 (29.50)	11(14)	F4(F8)
WP45-12(N)★	12	38.25	45	197.7	166	171	171	7.78	6.54	6.73	6.73	14.50	31.90	11(14)	F4(F8)
WP50-12(N)	12	42.5	50	199	166	171	171	7.83	6.54	6.73	6.73	15.10	33.22	11(14)	F4(F8)
KPH100-12AN(AU)	12	85	100	307	168	208	213 (230)	12.09	6.61	8.19	8.39 (9.06)	30.00	66.00	9(10)	F8(F15)
KPH110-12N	12	93.5	110	338	170	212	217	13.31	6.69	8.35	8.54	31.20	68.60	9	F8
KPH150-12N	12	127.5	150	352	170	273	278	13.86	6.69	10.75	10.95	46.00	101.20	9	F8

ELECTRONIC / SECURITY BACK UP POWER BATTERIES SERIES

WP3-6	6	2.55	3	134	34	59	65	5.28	1.34	2.32	2.56	0.67	1.47	2	F1
WPS4-6	6	3.4	4	70	47	102	106	2.76	1.85	4.02	4.17	0.745	1.64	1	F1
WP4.5-6	6	3.825	4.5	70	47	102	106	2.76	1.85	4.02	4.17	0.82	1.80	1	F1
WP5-6	6	4.25	5	70	47	102	106	2.76	1.85	4.02	4.17	0.83	1.83	1	F1
WPS2.3-12	12	1.995	2.3	178	34.5	60	66	7.01	1.36	2.36	2.60	0.87	0.86	2	F1
WPS4-12	12	3.4	4	90	70	101.5	107	3.54	2.76	4.00	4.21	1.50	3.30	3	F1
WPS5-12	12	4.25	5	90	70	101.5	107	3.54	2.76	4.00	4.21	1.62	3.56	3	F1
WPS7-12	12	5.65	7	151	65	94	102	5.94	2.56	3.70	4.02	2.00	4.40	5	F1
WP7.2-12A★	12	6.12	7.2	151	65	94	102	5.94	2.56	3.70	4.02	2.35	5.17	5	F1
WPS8-12	12	6.8	8	151	65	94	102	5.94	2.56	3.70	4.02	2.30	5.06	5	F1
WPS12-12	12	10.2	12	151	98	93	98	5.94	3.86	3.66	3.86	3.68	8.10	5	F1
WPS17-12	12	13.73	17	181	76	167	167	7.13	2.99	6.57	6.57	4.81</			

SPECIFICATION

BATTERY TYPE	NOMINAL VOLTAGE (V)	NOMINAL CAPACITY (Ah)		DIMENSION								WEIGHT (APPROX.)		ASSEMBLY FIGURE	
		5HR	20HR	L	W	H	HT	L	W	H	HT	kg	lbs	TERMINAL POSITION	TERMINAL TYPE
				mm	mm	mm	mm	in	in	in	in				

DEEP CYCLE HME MOBILITY (HEALTHLINC MEDICAL EQUIPMENT)

WP5-12E	12	4.25	5	90	70	101.5	107	3.54	2.76	4.00	4.21	1.90	4.18	3	F2
WP10-12SE	12	8.5	10	151	65	112	118.5	5.94	2.56	4.41	4.67	3.29	7.24	5	F2
WP12-12E	12	10.2	12	151	98	93	98	5.94	3.86	3.66	3.86	4.02	8.84	5	F2
WP14-12SE	12	11.9	14	151	98	95	100	5.94	3.86	3.74	3.94	4.40	9.68	5	F2
WP14-12NE	12	11.9	14	151	98	95	95	5.94	3.86	3.74	3.74	4.40	9.68	25	F6
WP15-12(N)SE	12	12.75	15	151	99	98	103(99)	5.94	3.90	3.86	4.05(3.90)	4.50	9.90	27(25)	F2(F6)
WP20-12IE	12	17	20	181	76	167	167	7.13	2.99	6.57	6.57	5.95	13.09	11	F3
WP22-12NE	12	18.7	22	181	76	167	167	7.13	2.99	6.57	6.57	6.90	15.18	14	F8
WP24-12ANE	12	20.4	24	181	77.5	169	169	7.13	3.05	6.69	6.69	7.14	15.70	14	F6
WP26-12(N)E	12	22.1	26	166	175	125	125	6.54	6.89	4.92	4.92	9.30	20.50	21(14)	F3(F6)
WP26-12TNE	12	22.1	26	166	125.5	176	176	6.54	4.94	6.93	6.93	8.80	19.36	21	F3
WP30-12TNE	12	25.5	30	166	125.5	176	176	6.54	4.94	6.93	6.93	9.70	21.30	14	F8
WP40-12(N)E	12	34	40	197.7	166	171	171	7.78	6.54	6.73	6.73	13.50(13.40)	29.70(29.50)	11(14)	F4(F8)
WP45-12NE	12	38.25	45	197.7	166	171	171	7.78	6.54	6.73	6.73	13.40	29.50	14	F8
WP50-12NE	12	42.5	50	199	166	171	171	7.83	6.54	6.73	6.73	15.10	33.22	14	F8
WP55-12NE	12	46.75	55	226	135	207	214	8.90	5.31	8.15	8.43	17.30	38.06	9	F8
WPL100-12RNE	12	85	100	329.5	172.3	215	222	12.97	6.78	8.46	8.74	30.00	66.00	9	F18
22NF305CNE	12	52.7	62	226	135	207	214	8.90	5.31	8.15	8.43	18.70	41.10	14	F8
KPH75-12NE	12	63.75	75	260	170	202	207	10.24	6.69	7.95	8.15	24.40	53.68	9	F8
KPH100-12ANE	12	85	100	307	168	208	214	12.09	6.61	8.19	8.43	30.00	66.00	9	F8
KPH110-12NE	12	85	110	338	170	212	217	13.31	6.69	8.35	8.54	31.20	68.60	9	F8
U1-33H(N)	12	28.05	33	197	131	159	180(168)	7.76	5.16	6.26	7.09(6.61)	10.10	22.20	20(9)	F4(F6)
U1-34H(N)	12	28.9	34	197	131	159	180(168)	7.76	5.16	6.26	7.09(6.61)	10.50	23.10	20(9)	F4(F6)
U1-34HE	12	28.9	34	197	131	159	180	7.76	5.16	6.26	7.09	10.30	22.70	20	F4
U1-35NE	12	29.75	35	197	131	159	168	7.76	5.16	6.26	6.61	10.50	23.10	9	F8
U1-36HH★	12	30.6	36	197	131	159	180	7.76	5.16	6.26	7.09	11.00	24.20	20	F4
U1-36NE	12	30.6	36	197	131	159	168	7.76	5.16	6.26	6.61	11.00	24.20	9	F8

GEL BATTERIES SERIES

LG17-12	12	14.45	17	181	76	167	167	7.13	2.99	6.57	6.57	6.30	13.86	21	F3
LG20-12N	12	17	20	181	76	167	167	7.13	2.99	6.57	6.57	6.70	14.74	14	F6
LG24-12(N)	12	20.4	24	166	175	125	125	6.54	6.89	4.92	4.92	9.30	20.46	21(14)	F3(F6)
LG32-12(N)	12	27.2	32	197	131	159	180	7.76	5.16	6.26	7.09	10.40	22.88	20(9)	F4(F8)
LG36-12N	12	30.6	36	197	131	159	170	7.76	5.16	6.26	6.69	10.70	23.54	9	F8
LG40-12(N)	12	34	40	197.7	166	171	171	7.78	6.54	6.73	6.73	13.30	29.30	11(14)	F4(F8)
LG45-12(N)	12	38.25	45	199	166	171	171	7.83	6.54	6.73	6.73	15.00	33.00	11(14)	F4(F8)
LG50-12(N)	12	42.5	50	199	166	171	171	7.83	6.54	6.73	6.73	14.80	32.60	11(14)	F4(F8)
LG55-12N	12	46.75	55	226	135	207	214	8.90	5.31	8.15	8.43	17.00	37.40	9	F8
LG22NF305CN	12	52.7	62	226	135	207	214	8.90	5.31	8.15	8.43	18.50	40.70	14	F8
LG65-12(N)	12	55.25	65	350	166	174	174	13.78	6.54	6.85	6.85	23.90	52.58	15(14)	F4(F8)
LGK75-12N	12	63.75	75	260	170	202	207	10.24	6.69	7.95	8.15	24.80	54.60	9	F8
LGK100-12N	12	85	100	338	170	212	217	13.31	6.69	8.35	8.54	34.00	74.80	9	F8
LGL150-12N	12	127.5	150	483	170	240	240	19.02	6.69	9.45	9.45	45.80	101.00	9	F18
LGL200-12BN	12	170	200	522	238	219	224	20.55	9.37	8.62	8.82	61.50	135.00	22	F18

SPECIAL TYPE BATTERIES

WP2-12	12	1.7	2	150	20	90	90	5.91	0.79	3.54	3.54	0.728	1.60	12	F1
WP1222A	12	1.7	2	182	23	61	61	7.17	0.91	2.40	2.40	0.69	1.52	18	F13
WP1223A	12	1.79	2.1	182	23	61	61	7.17	0.91	2.40	2.40	0.714	1.57	18	F13

- VdS Approved Model ★
- For batteries' capacity below 18Ah, all dimensions given are +/-1mm (0.04 inches)

BATTERY TYPE	NOMINAL VOLTAGE (V)	NOMINAL CAPACITY (Ah)		DIMENSION								WEIGHT (APPROX.)		ASSEMBLY FIGURE	
		5HR	20HR	L	W	H	HT	L	W	H	HT	kg	lbs	TERMINAL POSITION	TERMINAL TYPE
				mm	mm	mm	mm	in	in	in	in				

LONG LIFE POWER BATTERIES SERIES

WPL5-12	12	4.25	5	90	70	101.5	107	3.54	2.76	4.00	4.21	1.85	4.07	3	F1
WPL5-12SHR	12	4.25	5	90	70	101.5	107	3.54	2.76	4.00	4.21	1.93	4.25	3	F2
WPL7.2-12	12	6.12	7.2	151	65	94	102	5.94	2.56	3.70	4.02	2.40	5.28	5	F1
WPL1235W	12	35W	8.5	151	65	94	102	5.94	2.56	3.70	4.02	2.70	5.94	5	F2
WPL12-12	12	10.2	12	151	98	93	98	5.94	3.86	3.66	3.86	4.02	8.84	5	F1
WPL14-12S	12	11.9	14	151	98	95	100	5.94	3.86	3.74	3.94	4.30	9.46	5	F2
WPL18-12SHR	12	15.3	18	181	76	167	167	7.13	2.99	6.57	6.57	5.67	12.47	11	F3
WPL18-12NSHR	12	15.3	18	181	76	167	167	7.13	2.99	6.57	6.57	5.67	12.47	14	F6
WPL26-12B	12	22.1	26	166	175	125	125	6.54	6.89	4.92	4.92	8.00	17.60	21	F3
WPL26-12NB	12	22.1	26	166	175	125	125	6.54	6.89	4.92	4.92	8.00	17.60	14	F6
WPL26-12	12	22.1	26	166	175	125	125	6.54	6.89	4.92	4.92	9.30	20.46	21	F3
WPL26-12N	12	22.1	26	166	175	125	125	6.54	6.89	4.92	4.92	9.30	20.46	14	F6
WPL28-12TN	12	23.8	28	166	125.5	176	176	6.54	4.94	6.93	6.93	9.18	20.20	14	F6
WPL28-12TM	12	23.8	28	166	125.5	176	176	6.54	4.94	6.93	6.93	9.18	20.20	14	F9
WPL34-12N	12	28.9	34	197	131	159	168	7.76	5.16	6.26	6.61	10.30	22.70	9	F6
WPL36-12N	12	30.6	36	197	131	159	168	7.76	5.16	6.26	6.61	11.00	24.20	9	F8
WPL40-12	12	34	40	197.7	166	171	171	7.78	6.54	6.73	6.73	13.50	29.70	11	F4
WPL40-12N	12	34	40	197.7	166	171	171	7.78	6.54	6.73	6.73	13.40	29.50	14	F8
WPL45-12	12	38.25	45	199	166	171	171	7.83	6.54	6.73	6.73	14.60	32.10	11	F4
WPL45-12N	12	38.25	45	199	166	171	171	7.83	6.54	6.73	6.73	14.60	32.10	14	F8
WPL50-12	12	42.5	50	199	166	171	171	7.83	6.54	6.73	6.73	14.80	32.60	11	F4
WPL50-12N	12	42.5	50	199	166	171	171	7.83	6.54	6.73	6.73	14.80	32.60	14	F8
WPL55-12	12	46.75	55	226	135	207	229	8.90	5.31	8.15	9.02	17.00	37.40	10	F15
WPL55-12N	12	46.75	55	226	135	207	214	8.90	5.31	8.15	8.43	17.00	37.40	9	F8
WPL60-12AN	12	51	60	350	167	179	179	13.78	6.57	7.05	7.05	20.50	45.10	14	F8
WPL60-12ARN	12	51	60	350	167	179	179	13.78	6.57	7.05	7.05	20.50	45.10	9	F8
WPL65-12AN	12	55.25	65	350	167	179	179	13.78	6.57	7.05	7.05	21.00	46.20	14	F8
WPL65-12ARN	12	55.25	65	350	167	179	179	13.78	6.57	7.05	7.05	21.00	46.20	9	F8
WPL90-12N	12	76.5	90	329.5	172.3	215	222	12.97	6.78	8.46	8.74	29.00	63.80	14	F18
WPL100-12N	12	85	100	329.5	172.3	215	222	12.97	6.78	8.46	8.74	31.30	68.90	14	F18
WPL100-12RN	12	85	100	329.5	172.3	215	222	12.97	6.78	8.46	8.74	31.30	68.90	9	F18
WPL120-12N	12	102	120	408	177	224	224	16.06	6.97	8.82	8.82	35.50	78.10	14	F18
WPL120-12RN	12	102	120	408	177	224	224	16.06	6.97	8.82	8.82	35.50	78.10	9	F18
WPL125-12RN	12	106.25	125	408	177	244	224	16.06	6.97	9.61	8.82	39.60	87.12	9	F18
WPL130-12N	12														

CHARACTERISTIC

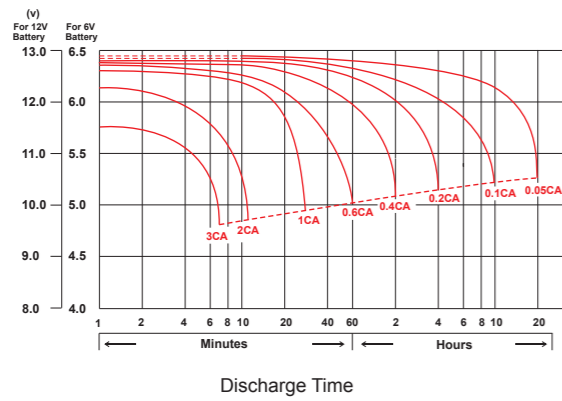

Discharge Time vs Discharge Current

Discharge Current (A)	Final Discharge Voltage (V/cell)	Recommended Setting for Equipment (V/cell)
(A) ≤ 0.2C	1.75	1.75 ↑
0.2C < (A) ≤ 0.5C	1.70	1.75 ↑
0.5C < (A) ≤ 3.0C	1.60	1.75 ↑
(A) > 3.0C	1.40	1.75 ↑

Discharge Protection of Batteries

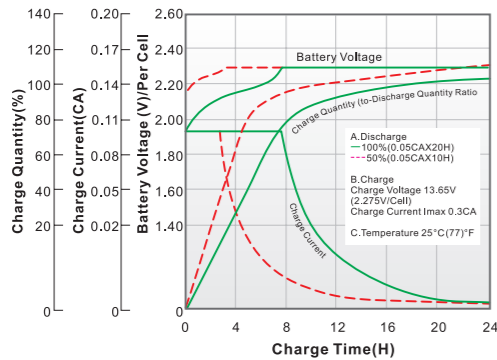

Battery Voltage and Charge Time for Standby Use

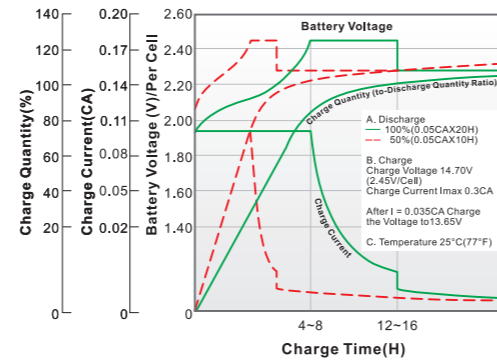

Battery Voltage and Charge Time for Cycle Use

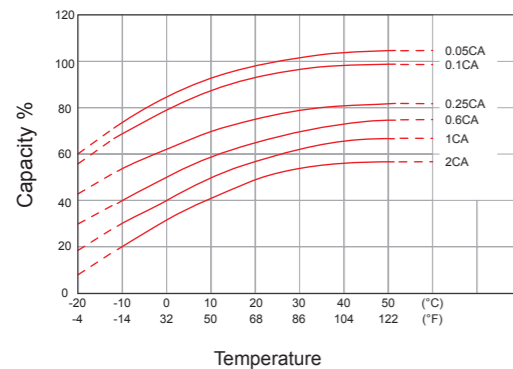

Effect of Temperature on Capacity

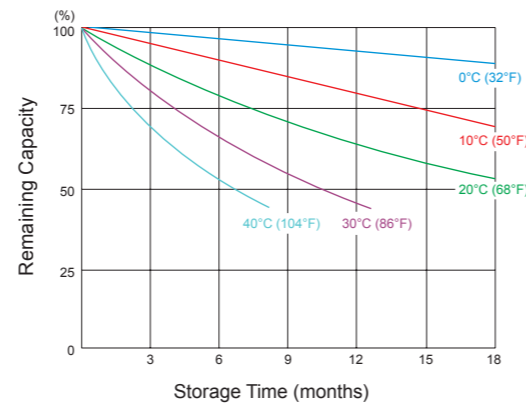

Capacity Retention Characteristic

CHARACTERISTIC

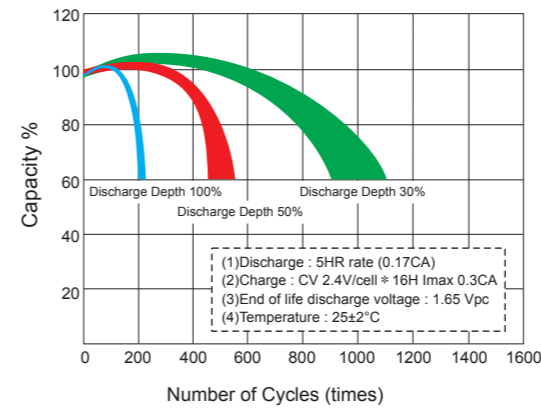

Cycle Service Life

Diameter	Recommended Torque Value	Maximum Allowable Torque Value
M5	4 N-m (41kgf-cm)	6 N-m (61kgf-cm)
M6	7 N-m (71kgf-cm)	10 N-m (102kgf-cm)
M8	12 N-m (122kgf-cm)	20 N-m (204kgf-cm)

Torque Value of Hard Ware for the Terminals

CHARGING METHOD

High performance and long service life of LONG battery depend on correct charging. Improper charging modes or inadequate charging equipment results in decreased battery life and/ or unsatisfactory performance.

Any of the conventional charging techniques may be used, but to obtain maximum service life and capacity, along with acceptable recharge time, constant current/ constant voltage charging is recommended.

A charge quantity of 105-120% of the previous discharged quantity is needed for fully charging the battery. The charging voltage of the battery decreases with increasing temperature and increases with decreasing temperature. At a temperature below 5°C (41°F) or above 35°C (95°F), the temperature compensation for charging voltage is necessary. At ambient temperature the compensation will not be necessary.

Overcharging should be avoided : As a result of too high a charge voltage. Excessive current will flow after reaching full charge, causing decomposition of water in the electrolyte and, hence, premature aging.

Undercharging should also be avoided : If too low a charge voltage is applied, the charger current output will essentially stop before the battery is fully charged. This allows some of the lead sulfate to remain on the plates which will eventually reduce capacity.

Recommended Recharging Interval & Method

Storage Temperature	Recharge Interval & Method
Below 20°C (68°F)	9 months, charge for 16~20 hrs at 2.4V/cell
20°C-30°C (68°F-86°F)	6 months, charge for 16~20 hrs at 2.4V/cell
Above 30°C (86°F) (avoid this storage condition)	3 months, charge for 16~20 hrs at 2.4V/cell

HANDLING INSTRUCTION

- Do not shorten the terminals.
- Do not place the battery near or on fire.
- Do not use the battery in a container or bag without proper ventilation.
- Operate at a temperature between -15°C to 50°C. But for cycle use, the 5°C to 35°C temperature range is recommended.
- To properly store the battery, remove it from the equipment or charge and store it in a dry and cool place.
- Immediately recharge after discharging.
- If sulfuric acid from the battery is spilled on skin or clothing, wash immediately with water. If acid comes in contact with eyes, flush with large amounts of water and immediately see a doctor.
- To obtain maximum life, the ripple current at the RMS forward current of the charger should be regulated to 10% less than its output value.
- Avoid mixed use of batteries. Different capacities, histories, or manufacturers of batteries may cause damage to the batteries or other equipment's.



HIGH RATE LONG LIFE (High Performance)

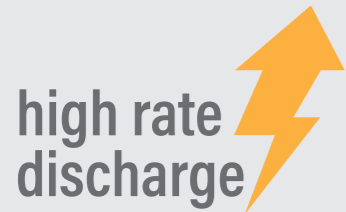

Excellent high rate discharge performance



Constructed with high purity lead 99.990wt% above



Optional ABS case with UL 94V-0 Flame retardant rating (LOI > 28%)



Maintenance Free & Non-Spillable



Low self-discharge rate (about 2%/ month at 25°C)



The gas recombination efficiency is up to 99%

BATTERY MODEL	NOMINAL VOLTAGE (V)	20 HR Rate to 1.75V/cell at (25°C)	@15 min Rate to 1.67V/cell at (25°C)	DIMENSION								WEIGHT (APPROX.)		SHORT CIRCUIT CURRENT (A)	INTERNAL RESISTANCE (mΩ)	TERMINAL POSITION	TERMINAL TYPE
				L	W	H	HT	L	W	H	HT	kg	lbs				
				mm	mm	mm	mm	in	in	in	in						

TOP TERMINAL TYPE																	
WXL1225W	12	5	23W	90	70	101.5	107	3.54	2.76	4	4.21	1.97	4.33	240	17	3	F2
WXL1235W	12	8.5	35W	151	65	94	102	5.94	2.56	3.7	4.02	2.7	5.94	260	14	5	F2
WXL1251W	12	12	51W	151	98	95	100	5.94	3.86	3.74	3.94	4.3	9.46	350	8	5	F2
WXL1280WN	12	20	80W	181	76	167	167	7.13	2.99	6.57	6.57	5.95	13.1	650	10	14	F6
WXL12100WN	12	28	100W	166	125.5	176	176	6.54	4.94	6.93	6.93	9.2	20.2	980	9.2	14	F6
WXL12135WN	12	36	135W	197	131	159	168	7.76	5.16	6.26	6.61	11	24.2	1010	8	9	F8
WXL12150WN	12	40	150W	197.7	166	171	171	7.78	6.54	6.73	6.73	13.4	29.5	1100	7.5	14	F8
WXL12205WN	12	55	215W	226	135	207	214	8.9	5.21	8.15	8.43	17.1	37.6	1500	8	9	F8
WXL12245WN	12	65	245W	350	167	179	179	13.78	6.57	7.05	7.05	20.5	45.1	1700	6	9	F18
WXL12265WN	12	70	265W	350	167	179	179	13.78	6.57	7.05	7.05	22.5	49.5	1850	3.9	9	F18
WXL12300WN	12	75	300W	260	170	202	207	10.24	6.69	7.95	8.15	24.2	53.24	2000	5	9	F18
WXL12365WN	12	95	365W	306	168	206	213	12.05	6.61	8.11	8.38	29.5	64.9	2350	5	9	F18
WXL12420WN	12	110	420W	341	173	215	219	13.43	6.81	8.46	8.62	34	74.8	3660	3.9	9	F18
WXL12450WN	12	115	450W	376	172	221	225	14.8	6.77	8.7	8.86	37.5	82.5	3750	2.5	9	F18
WXL12505WN	12	130	505W	338	173	276	281	13.31	6.81	10.87	11.06	42	92.4	3183	4	9	F18
WXL12550WN	12	140	550W	338	173	276	281	13.31	6.81	10.87	11.06	45	99	3850	3.5	9	F18
WXL12710WN	12	200	710W	532	207	214	219	20.94	8.15	8.43	8.62	58	127.6	3350	3	22	F18
WXL12820WN	12	230	820W	522	238	219	224	20.55	9.37	8.62	8.82	66.4	146	4040	2.2	22	F18

FRONT TERMINAL TYPE																	
WXL12345WFT	12	100	345W	507	106	235	235	19.96	4.17	9.25	9.25	30	66	2124	4.3	23	F18
WXL12450WFT	12	150	450W	550	110	288	288	21.65	4.33	11.34	11.34	44.3	97.5	2432	4.5	23	F18
WXL12500WFT	12	150	500W	550	110	288	288	21.65	4.33	11.34	11.34	50.5	111	2670	4.5	23	F18
WXL12600WFT	12	160	600W	550	110	288	288	21.65	4.33	11.34	11.34	54	118.8	2800	3.2	23	F18
WXL12710WFT	12	190	710W	546	125	320	320	21.5	4.92	12.6	12.6	60	132	3481	3.8	23	F18

- For batteries' capacity above 18Ah, all dimensions given are +2/-1mm (+0.08/-0.04 inches)
- Please refer to all the details of the specification sheet
- In accordance with IEC60896-21/ 22: 2004

CHARACTERISTIC

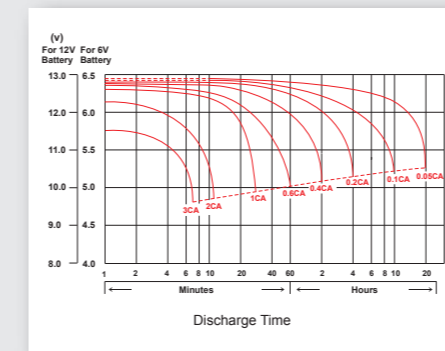

Discharge Time vs Discharge Current

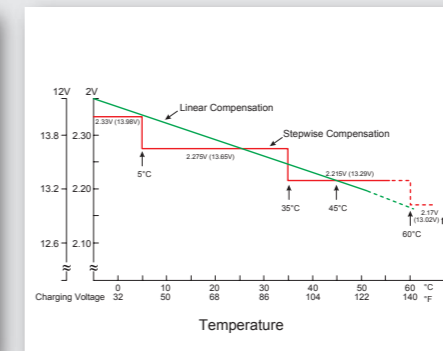

Effect of Temperature on Capacity

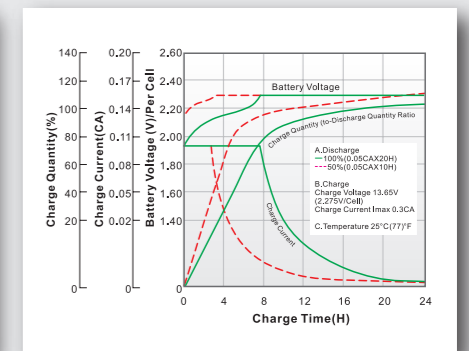

Battery Voltage and Charge Time for Standby Use

EXTREME HIGH RATE WXL SERIES



DISCHARGE WATTS PER CELL to 1.67V/ cell at 25°C

BATTERY MODEL	MINUTES					
	5	10	15	20	30	60
WXL12245WN	423	323	249	209	153	87.9
WXL12265WN	484	340	262	214	159	92.5
WXL12300WN	633	435	340	268	203	98.9
WXL12365WN	747	484	365	291	216	123
WXL12420WN	805	547	444	335	249	146
WXL12450WN	869	601	477	360	288	164
WXL12505WN	837	615	508	403	291	142
WXL12550WN	1023	738	553	462	325	175
WXL12710WN	1180	848	711	605	467	268
WXL12820WN	1200	964	818	624	493	284
WXL12500WFT	643	542	499	-	297	187
WXL12710WFT	950	827	708	-	485	270

DISCHARGE WATTS PER CELL to 1.70V/ cell at 25°C

BATTERY MODEL	MINUTES					
	5	10	15	20	30	60
WXL12245WN	409	314	247	206	152	87.4
WXL12265WN	467	334	259	212	158	92.3
WXL12300WN	608	426	333	265	201	98.7
WXL12365WN	726	474	359	287	214	122
WXL12420WN	775	533	441	332	247	146
WXL12450WN	837	586	474	357	285	164
WXL12505WN	797	605	505	393	287	139
WXL12550WN	963	705	543	457	322	173
WXL12700WN	996	819	702	586	449	259
WXL12780WN	1142	919	778	599	479	276
WXL12500WFT	613	525	489	-	291	186
WXL12710WFT	921	777	683	-	470	269

DISCHARGE WATTS PER CELL to 1.75V/ cell at 25°C

BATTERY MODEL	MINUTES					
	5	10	15	20	30	60
WXL12245WN	390	295	244	203	150	86.6
WXL12265WN	442	317	252	207	156	91.7
WXL12300WN	573	415	326	261	197	98.4
WXL12365WN	686	454	345	277	208	119
WXL12420WN	738	518	439	329	244	145
WXL12450WN	797	570	472	353	282	163
WXL12505WN	740	587	479	377	281	148
WXL12550WN	893	672	530	450	317	171
WXL12710WN	997	805	679	560	432	248
WXL12820WN	1083	874	750	574	464	269
WXL12500WFT	580	505	456	-	272	182
WXL12710WFT	881	728	629	-	450	267

DISCHARGE WATTS PER CELL to 1.80V/ cell at 25°C

BATTERY MODEL	MINUTES					
	5	10	15	20	30	60
WXL12245WN	361	271	225	190	147	85.9
WXL12265WN	404	304	245	202	152	90
WXL12300WN	530	400	311	250	187	97.9
WXL12365WN	639	428	328	264	199	116
WXL12420WN	675	503	424	321	236	143
WXL12450WN	729	553	456	345	274	161
WXL12505WN	683	542	433	354	271	147
WXL12550WN	803	630	515	440	312	163
WXL12710WN	957	790	644	545	413	237
WXL12820WN	1024	829	678	549	449	261
WXL12500WFT	523	450	405	-	241	175
WXL12710WFT	792	673	569	-	426	260

BATTERY CABINET/RACK SYSTEM FOR ALL YOUR NEEDS

COOPER CONNECTOR

Bolt screw size (D)	L (A) (mm)	W (B) (mm)	H (C) (mm)	E (mm)	F (mm)
M6	115	30	4	71	97
M6	303	30	4	259	285
M6	236	30	4	192	218
M6	353	30	4	309	335
M6	370	30	4	333.5	352.5
M6	417	30	4	380.5	399.5
M6	370	30	10	333.5	352.5
M6	417	30	10	380.5	399.5
M8	134	18	2.5	99	119
M8	107	25	2.5	73	87
M8	140	40	5	95	117

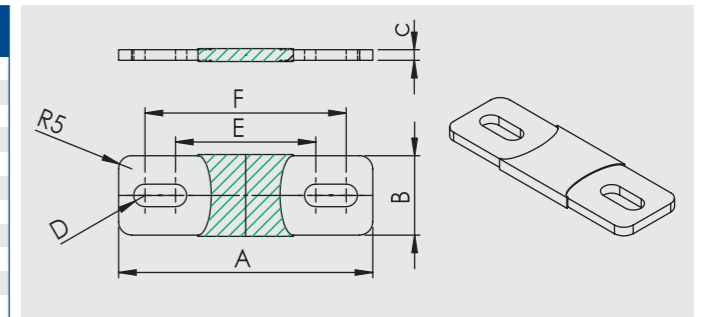

• Please contact LONG for information on the different cabinet and rack lengths and designs available.

BATTERY CABINET SYSTEMS

The Battery cabinet is designed to house standard VRLA Batteries with a variable capacity range.

GENERAL FEATURES

1. Robust cabinet.
2. Extreme durability.
3. Pressure relief filters eliminate smoke and fumes.
4. Customized protection device tailored to match your specific power rating.
5. Chemical Safety to protect shelves from H₂SO₄ corrosion that can cause risks of electric shock and short circuit (fire).

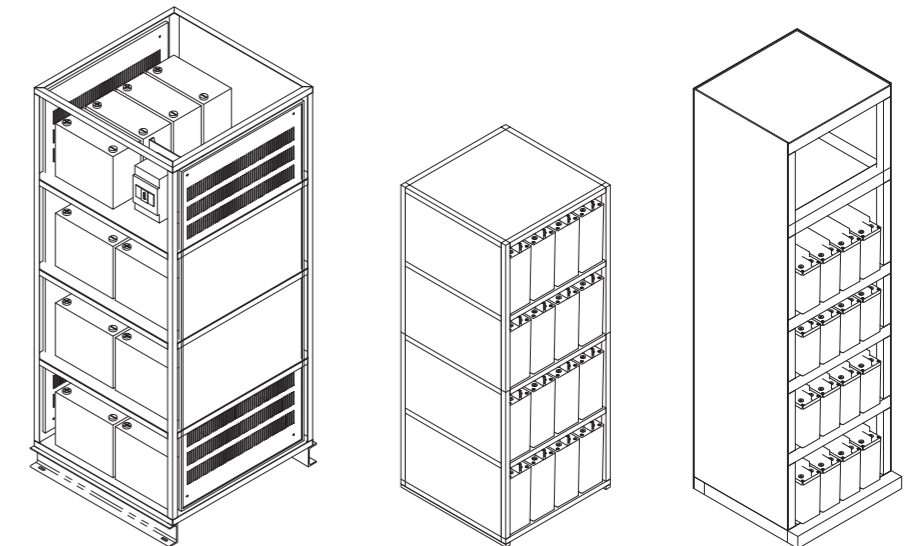

BATTERY RACK SYSTEMS

The battery racks have been designed for all types of stationary battery models. These easy-to-use racks are strong, have a flexible design, and are acid-proof.

GENERAL FEATURES

1. Extreme durability.
2. Acid-proof protection.
3. Floor mounting brackets included with all racks.
4. Racks can be customized with earthquake safety features according to the customer/ project requirement.

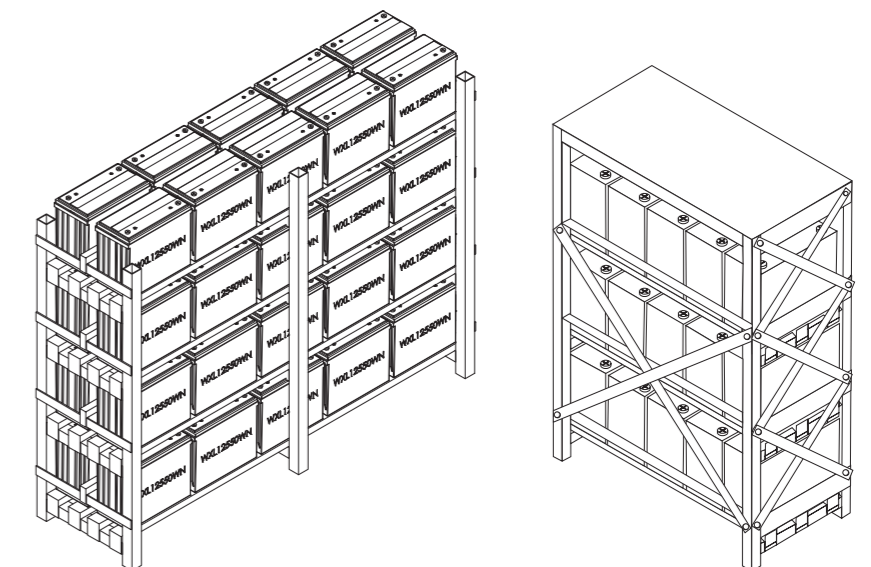

TPK & MSK & HTP



IDC/ UPS/ TELECOM (Easy to Install and Maintain)

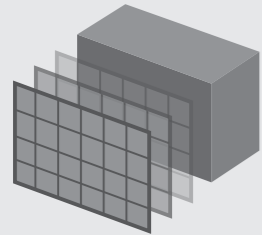

Reinforced grid/ plates design for optimal use



Offer a long service life up to 12 years



Maintenance Free & Non-Spillable



Easy installation & maintenance



99% above recyclable



Wide operating temperature

BATTERY TYPE	NOMINAL VOLTAGE (V)	NOMINAL CAPACITY (Ah)		DIMENSION								WEIGHT (APPROX.)		ASSEMBLY FIGURE	
		5HR	20HR	L	W	H	HT	L	W	H	HT	kg	lbs	TERMINAL POSITION	TERMINAL TYPE
				mm	mm	mm	mm	in	in	in	in				

IDC/ UPS/ TELECOM SERIES

TPK12100A	12	85	100	507	106	235	235	19.96	4.17	9.25	9.25	31.30	68.90	23	F18
TPK12100HS	12	85	100	390	105	280	280	15.35	4.13	11.02	11.02	30.40	66.90	23	F18
TPK12125	12	106.3	125	550	110	288	288	21.65	4.33	11.34	11.34	39.00	85.80	23	F18
TPK12150NA	12	127.5	150	550	110	288	288	21.65	4.33	11.34	11.34	45.00	99.00	23	F18
TPK12150	12	127.5	150	550	110	288	288	21.65	4.33	11.34	11.34	50.50	111.00	23	F18
TPK12190	12	161.5	190	546	125	320	320	21.5	4.92	12.60	12.60	60.00	132.00	23	18

2V STATIONARY BATTERIES SERIES

MSK75	2	63.75	75	170	72	205	208	6.69	2.83	8.07	8.19	6.40	14.08	-	F18
MSK100A	2	85	100	170	72	205	208	6.69	2.83	8.07	8.19	7.50	16.50	-	F18
MSK200	2	170	200	170	106	333	342.5	6.69	4.17	13.11	13.48	14.00	30.80	-	F18
MSK300	2	255	300	170	150	333	342.5	6.69	5.91	13.11	13.48	21.20	46.60	-	F18
MSK400	2	340	400	197	170	333	342.5	7.76	6.69	13.11	13.48	25.50	56.10	-	F18
MSK440	2	374	440	197	170	333	342.5	7.76	6.69	13.11	13.48	29.70	65.30	-	F18
MSK500	2	425	500	241	172	329.5	340	9.49	6.77	12.97	13.39	33.50	73.70	-	F18
MSK600	2	510	600	241	172	329.5	340	9.49	6.77	12.97	13.39	35.70	78.54	-	F18
MSK1000SN	2	850	1000	303	172	477	488	11.93	6.77	18.78	19.21	62.50	137.5	-	F18

HIGH TEMPERATURE SERIES

FRONT TERMINAL TYPE

HTP12100A	12	85	100	507	106	235	235	19.96	4.17	9.25	9.25	34.00	74.80	23	F18
HTP12100H	12	90	100	395	110	286	286	15.55	4.33	11.26	11.26	31.50	69.30	23	F8
HTP12150	12	127.5	150	550	110	288	288	21.65	4.33	11.34	11.34	49.00	108.00	23	F18

TOP TERMINAL TYPE

HTP100-12N	12	85	100	338	170	212	217	13.31	6.69	8.35	8.54	32.50	71.50	9	F8
HTP100-12RN	12	85	100	329.5	172.3	215	222	12.97	6.78	8.46	8.74	31.50	69.30	9	F18
HTP120-12N	12	102	120	408	177	224	224	16.06	6.97	8.82	8.82	37.00	81.40	14	F18
HTP150-12N	12	127.5	150	483	170	240	240	19.02	6.69	9.45	9.45	48.40	106.00	9	F18
HTP200-12N	12	170	200	522	238	219	224	20.55	9.37	8.62	8.82	73.20	161.00	22	F18

- For batteries' capacity above 18Ah, all dimensions given are +2/-1mm (+0.08/-0.04 inches)
- Please refer to all the details of the specification sheet
- In accordance with IEC60896-21/ 22: 2004

CHARACTERISTIC

TPK & MSK & HTP SERIES

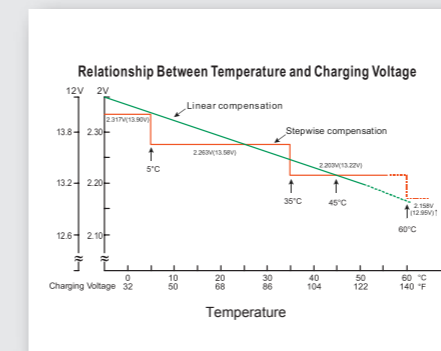

Relationship Between Temp. and Charging Voltage

TPK & HTP SERIES

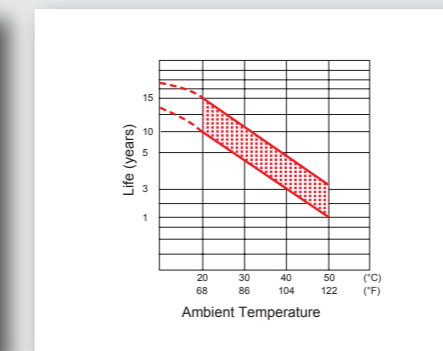

TPK & HTP Trickle (or Float) Service Life

MSK SERIES

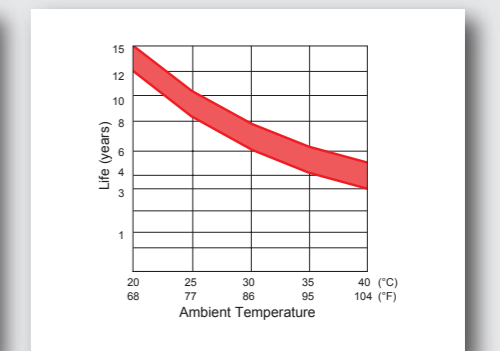

MSK Trickle (or Float) Service Life

WPG & CWP



Renewable Energy (An Ideal Solution for Storage of Solar Energy)

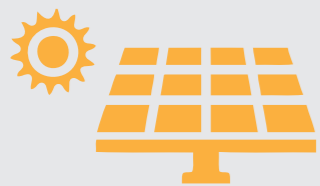

Photovoltaic energy system (PVES)



Wide operating temperature



Withstand Shock & Vibration Design

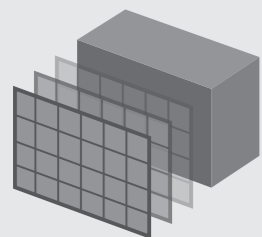

Reinforced grid/ plates design for optimal use

99%

The gas recombination efficiency is up to 99%

30% 1600 cycles

Cycle Life can reach 1600 cycles under 30% DOD

BATTERY TYPE	NOMINAL VOLTAGE (V)	NOMINAL CAPACITY (Ah)		DIMENSION								WEIGHT (APPROX.)		ASSEMBLY FIGURE	
		5HR	20HR	L	W	H	HT	L	W	H	HT	kg	lbs	TERMINAL POSITION	TERMINAL TYPE
RENEWABLE ENERGY															
CWP75-12N	12	63.75	75	260	170	202	207	10.24	6.69	7.95	8.15	24.20	53.24	9	F8
CWP100-12N	12	85	100	338	170	212	217	13.31	6.69	8.35	8.54	31.20	68.60	9	F8
CWP115-12N	12	97.75	115	338	170	212	217	13.31	6.69	8.35	8.54	34.50	75.90	9	F8
CWP150-12N	12	127.5	150	483	170	240	240	19.02	6.69	9.45	9.45	48.20	106.00	9	F18
CWP200-12N	12	170	200	522	238	219	224	20.55	9.37	8.62	8.82	68.00	150.00	22	F18
CWP220-12N	12	187	220	522	238	219	224	20.55	9.37	8.62	8.82	73.20	161.00	22	F18
WPG5-12	12	4.25	5	90	70	101.5	107	3.54	2.76	4.00	4.21	1.90	4.18	3	F2
WPG7.2-12	12	6.12	7.2	151	65	94	102	5.94	2.56	3.70	4.02	2.40	5.28	5	F2
WPG18-12N	12	15.3	18	181	76	167	167	7.13	2.99	6.57	6.57	6.30	13.86	14	F6
WPG26-12N	12	22.1	26	166	175	125	125	6.54	6.89	4.92	4.92	9.30	20.46	14	F6
WPG30-12T	12	25.5	30	166	125.5	176	176	6.54	4.94	6.93	6.93	10.50	23.10	21	F3
WPG40-12N	12	34	40	199	166	171	171	7.83	6.54	6.73	6.73	13.40	29.50	14	F8
WPG50-12N	12	42.5	50	199	166	171	171	7.83	6.54	6.73	6.73	15.10	33.22	14	F8
WPG55-12N	12	46.75	55	226	135	207	214	8.90	5.31	8.15	8.43	17.00	37.40	9	F8
WPG65-12N	12	55.25	65	350	166	174	174	13.78	6.54	6.85	6.85	23.30	51.30	14	F8
WPG100-12AN	12	85	100	307	168	208	214	12.09	6.61	8.19	8.43	30.00	66.00	9	F8
WPG110-12N	12	93.5	110	338	170	212	217	13.31	6.69	8.35	8.54	32.50	71.50	9	F8
WPG150-12N	12	127.5	150	483	170	240	240	19.02	6.69	9.45	9.45	45.50	100.00	9	F18
WPG200-12AN	12	170	200	522	238	219	224	20.55	9.37	8.62	8.82	63.00	138.60	22	F18

- For batteries' capacity above 18Ah, all dimensions given are +2/-1mm (+0.08/-0.04 inches)
- Please refer to all the details of the specification sheet

CHARACTERISTIC

CWP SERIES

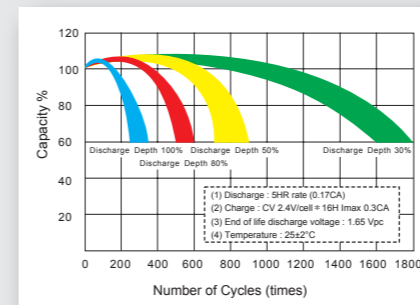

Cycle Service Life

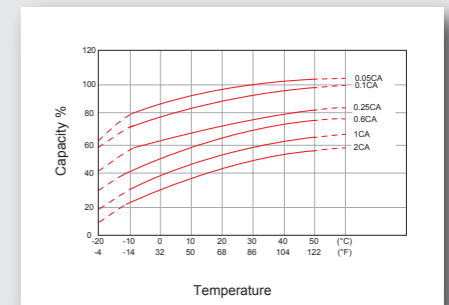

Effect of Temperature on Capacity

WPG SERIES

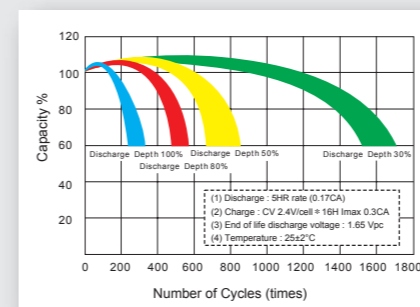

Cycle Service Life

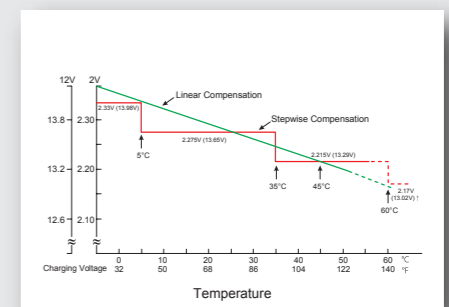

Relationship Between Temperature and Charging Voltage

PLG (FULL GEL)



True Gel Battery (Robust and Reliable)



Strong industrial design for long service life, leak-proof, low self-discharge

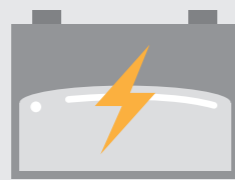

Valve regulated lead battery with electrolyte fixed in a Gel form

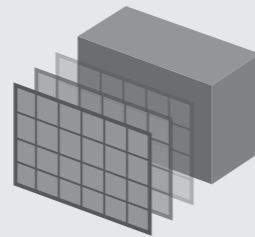

Reinforced grid/ plates design for optimal use



Low internal resistance



Robust/ Built to last

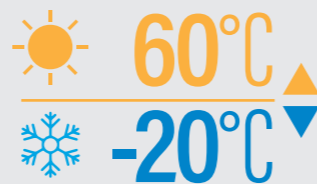

Wide operation (-20 ~ 60°C)

BATTERY TYPE	NOMINAL VOLTAGE (V)	NOMINAL CAPACITY (Ah)		DIMENSION								WEIGHT (APPROX.)		ASSEMBLY FIGURE	
		5HR	10HR	L	W	H	HT	L	W	H	HT	kg	lbs	TERMINAL POSITION	TERMINAL TYPE
				mm	mm	mm	mm	in	in	in	in				

TRUE GEL BATTERY

FULL GEL TOP TERMINAL TYPE

PLG100-12RN	12	85	100	329.5	172.3	215	222	12.97	6.78	8.46	8.74	31.30	68.90	9	F18
PLG120-12RN	12	102	120	408	177	224	224	16.06	6.97	8.82	8.82	37.00	81.40	9	F18
PLG150-12N	12	127.5	150	483	170	240	240	19.02	6.69	9.45	9.45	52.00	114.60	9	F18
PLG200-12AN	12	170	200	522	238	219	225	20.55	9.37	8.62	8.83	64.00	140.50	22	F18
PLG200-12N	12	176	200	522	238	219	225	20.55	9.37	8.62	8.85	68.00	149.90	22	F18

12V FULL GEL FRONT TERMINAL TYPE

PLG12150	12	115	150	550	110	287	287	21.65	4.33	11.2	11.2	50.00	110.00	23	F18
----------	----	-----	-----	-----	-----	-----	-----	-------	------	------	------	-------	--------	----	-----

2V FULL GEL TYPE

PLG200A	2	170	200	170	106	333	338	6.69	4.17	13.11	13.31	14.00	30.80	-	F18
PLG300A	2	240	300	170	150	333	342.5	6.69	5.91	13.11	13.48	20.00	44.00	-	F18
PLG400A	2	340	400	197	170	333	338	7.76	6.69	13.11	13.31	29.00	63.90	-	F18
PLG500A	2	400	500	241	172	329.5	340	9.49	6.77	12.97	13.39	29.00	63.80	-	F18
PLG600A	2	510	600	241	172	336	340	9.49	6.77	13.23	13.39	36.00	79.37	-	F18
PLG800A	2	680	800	474	174	338	354	18.67	6.85	13.31	13.94	55.00	121.25	-	F18
PLG1000A	2	850	1000	474	174	338	354	18.66	6.85	12.91	13.94	66.00	145.20	-	F18

- For batteries' capacity above 18Ah, all dimensions given are +2/-1mm (+0.08/-0.04 inches)
- Please refer to all the details of the specification sheet
- In accordance with IEC60896-21/ 22: 2004

CHARACTERISTIC

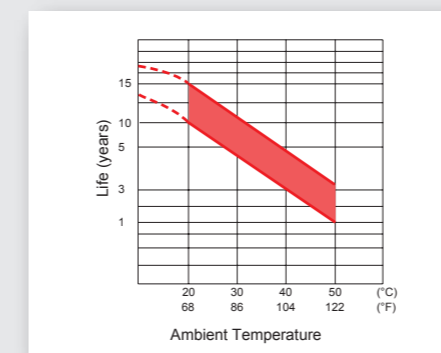

Trickle (or Float) Service Life

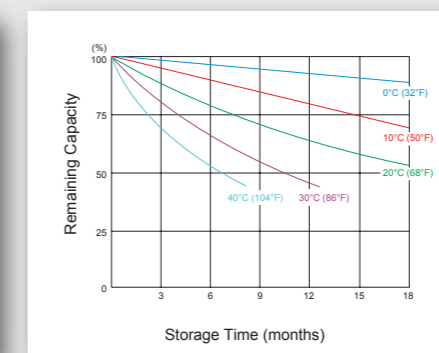

Capacity Retention Characteristic

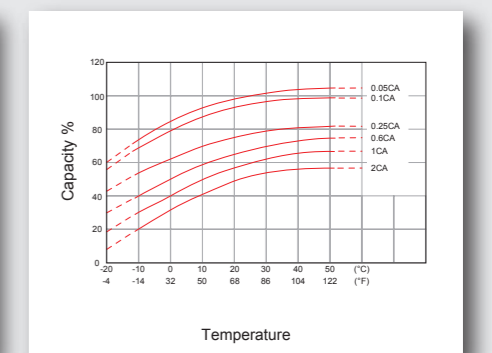

Effect of Temperature on Capacity 25°C (77°F)